

Canvas cutting diagram

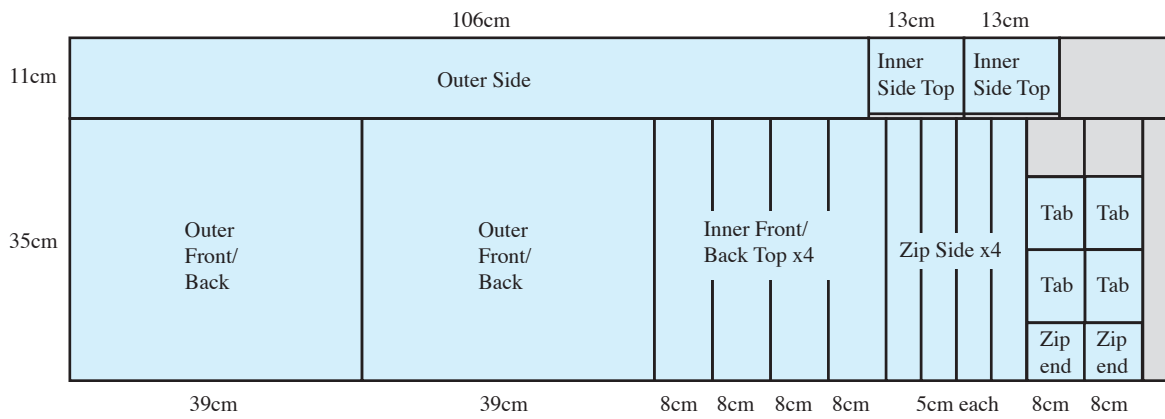

Lining cutting diagram

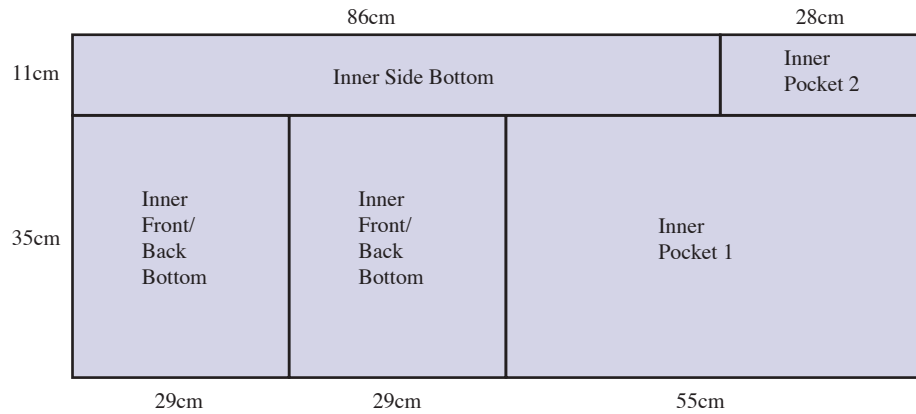

Interfacing diagram

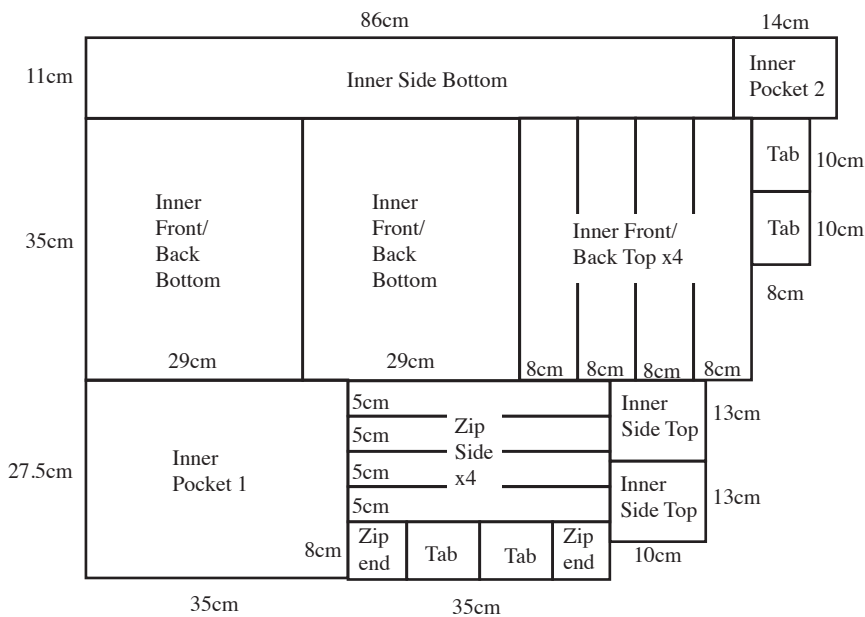

Step 3

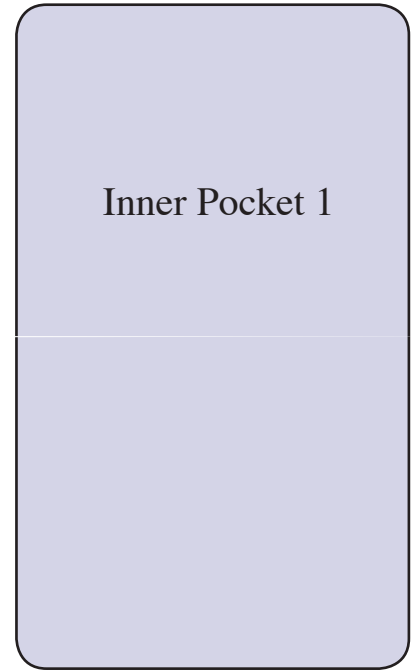
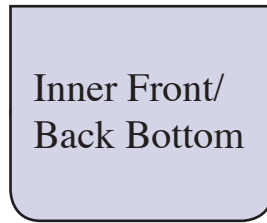
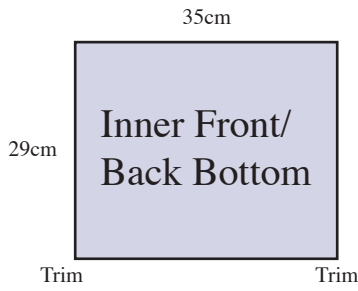
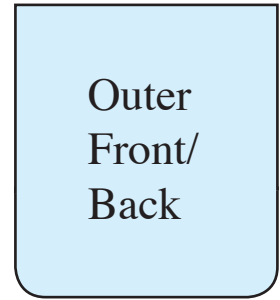
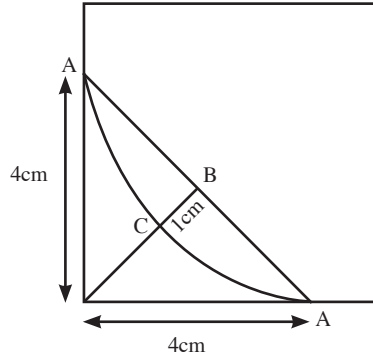
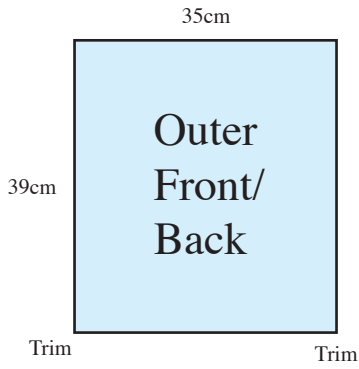

Step 4

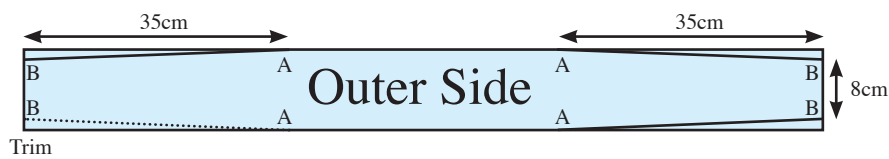
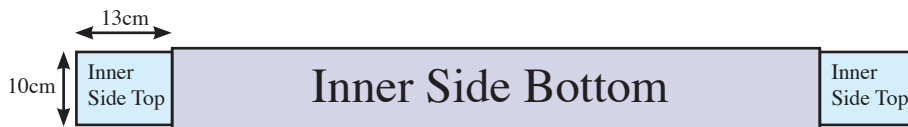

Step 5

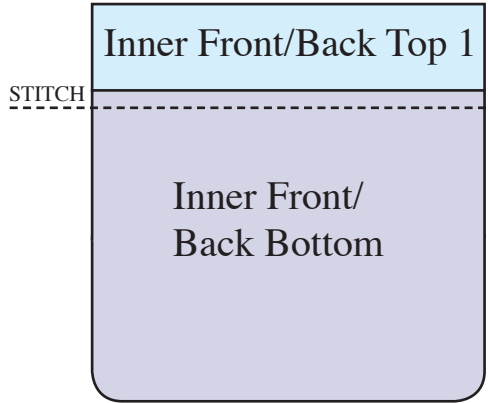
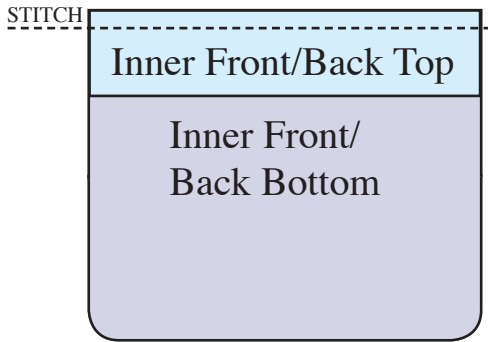

Step 6

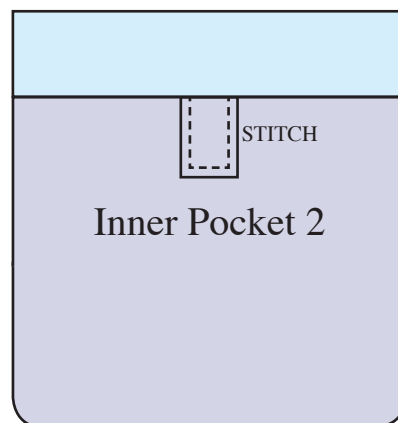
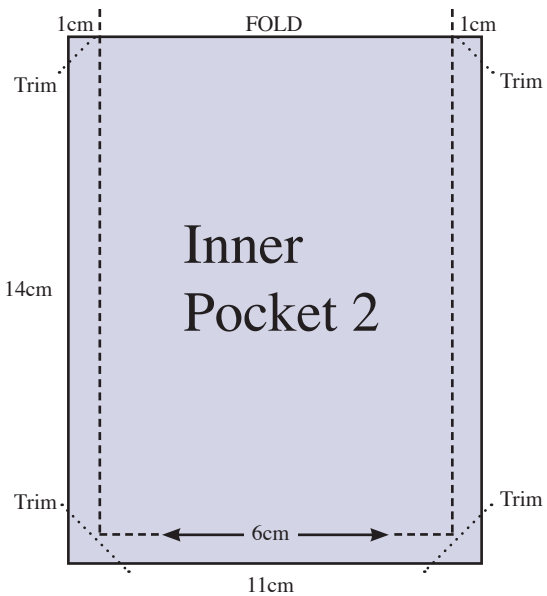
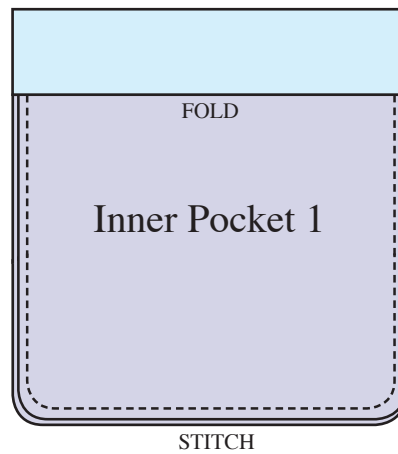
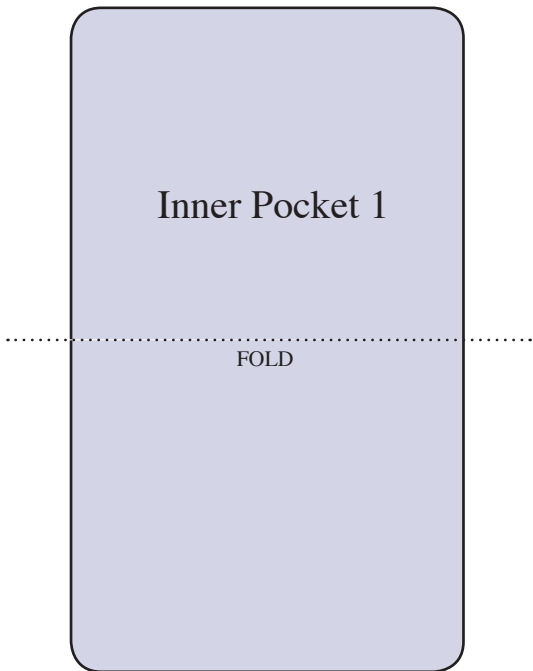

Step 7

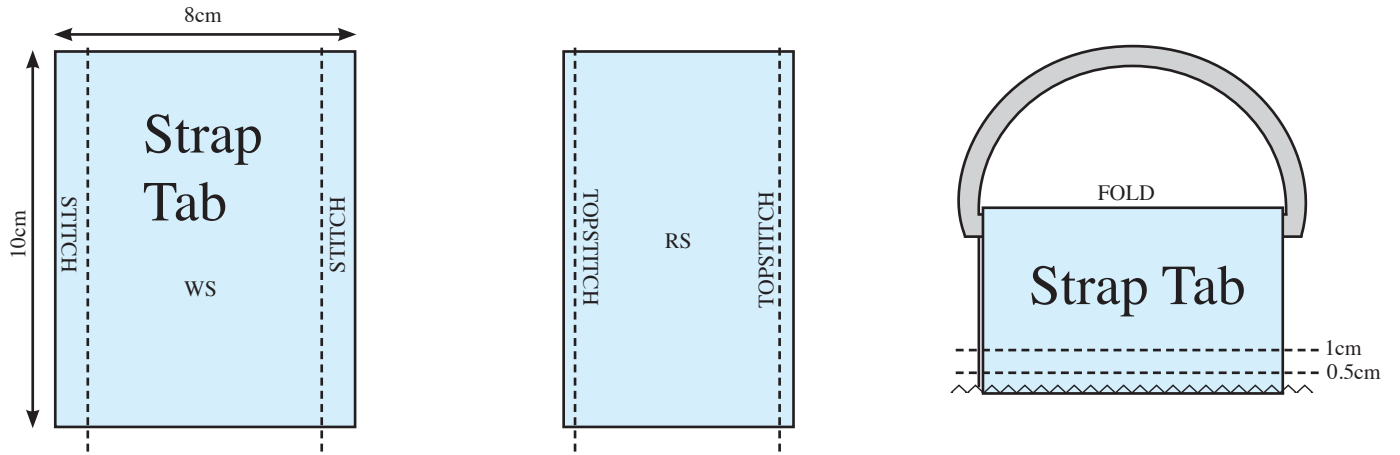

Step 8

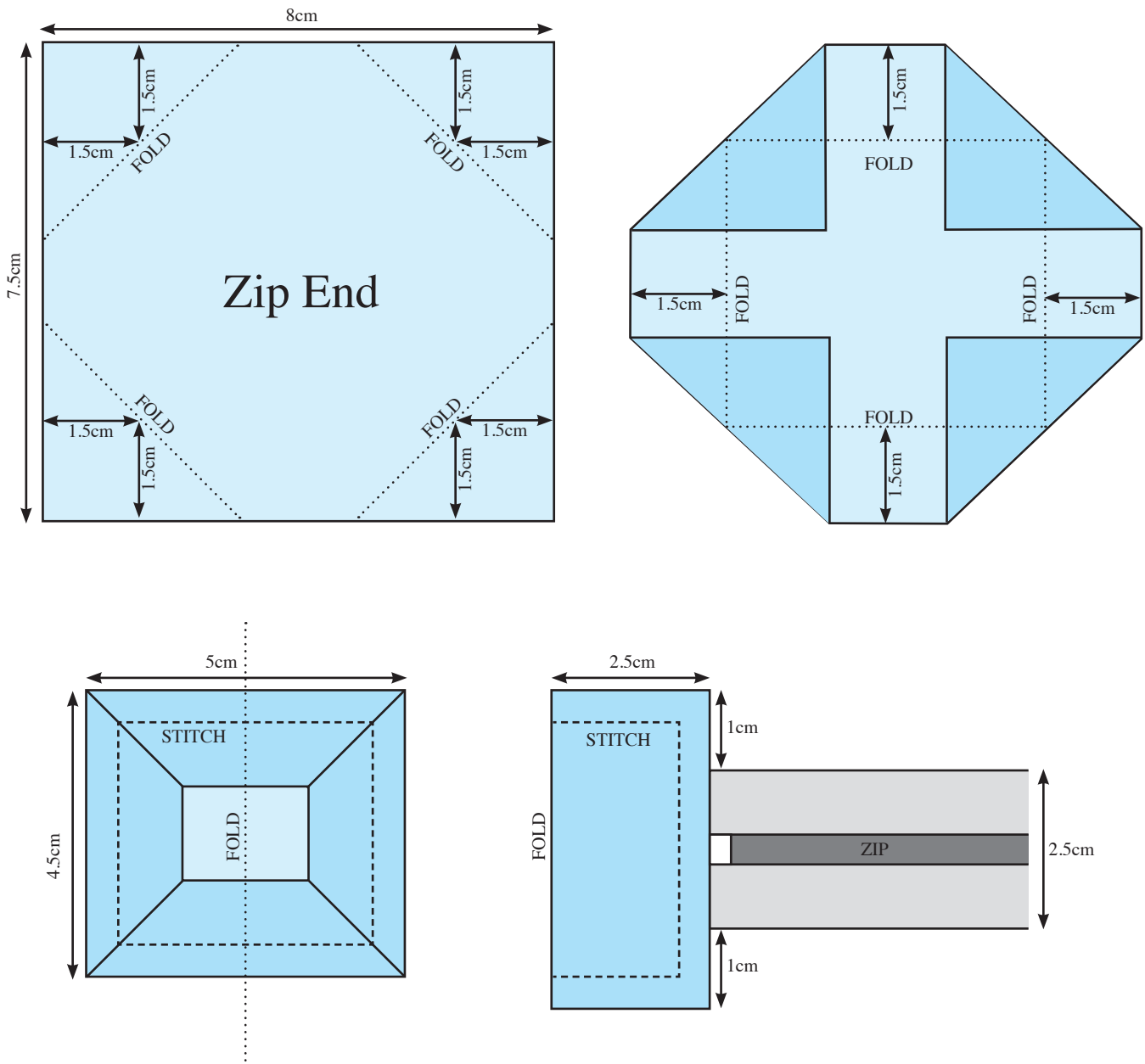

Step 9

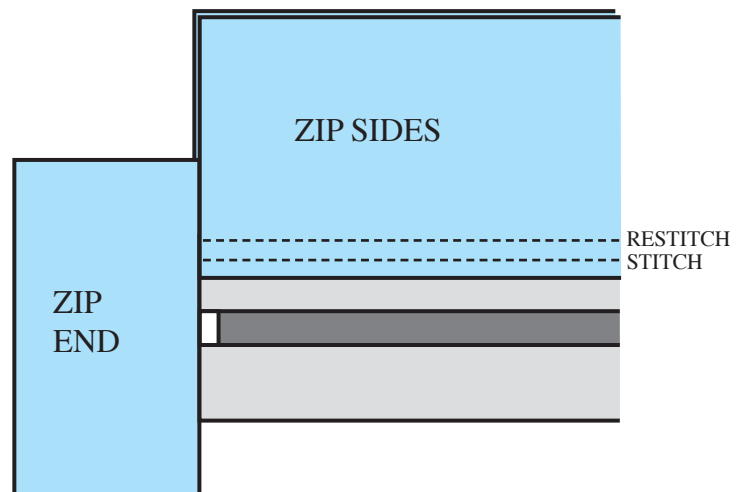
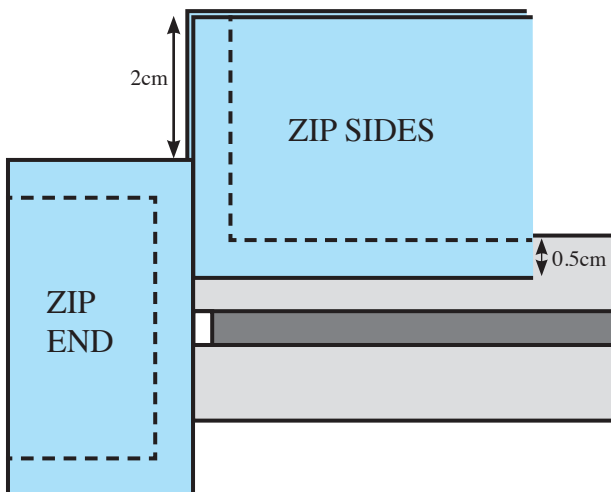
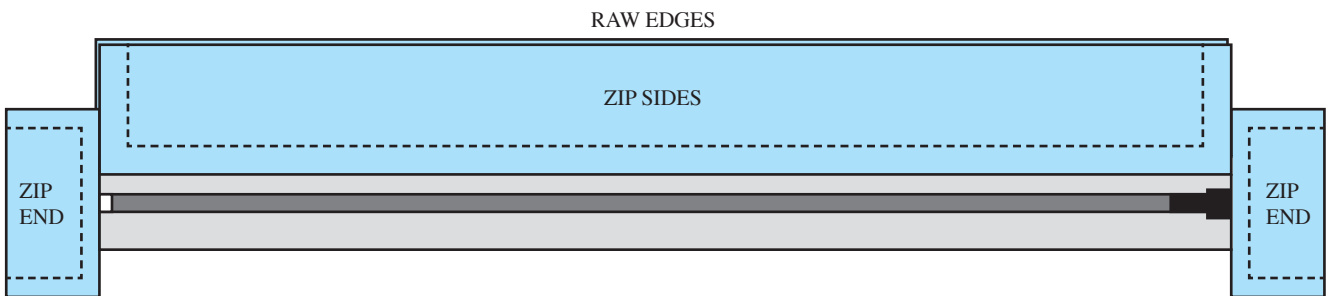
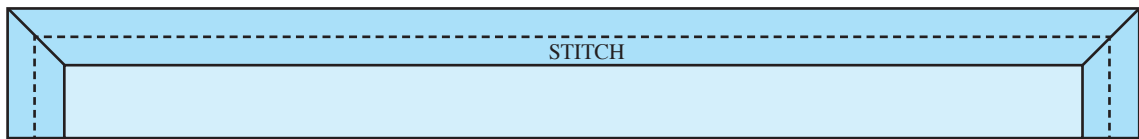
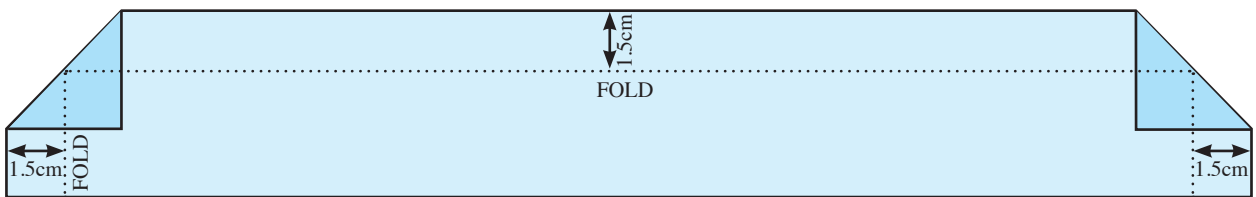
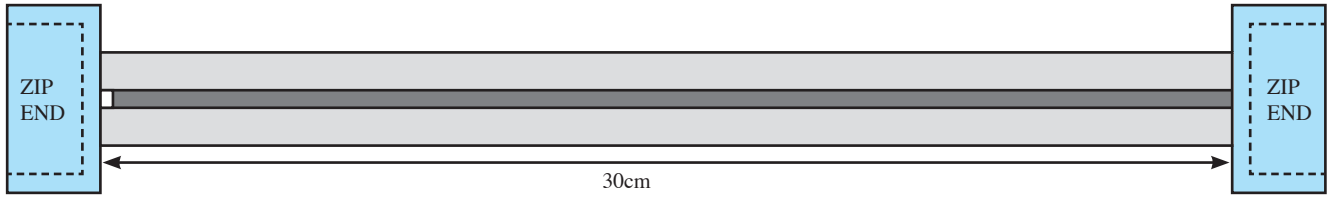

Step 10

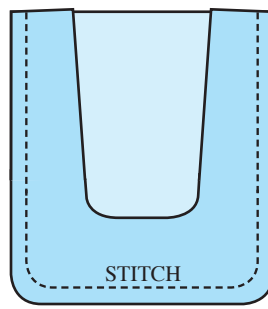
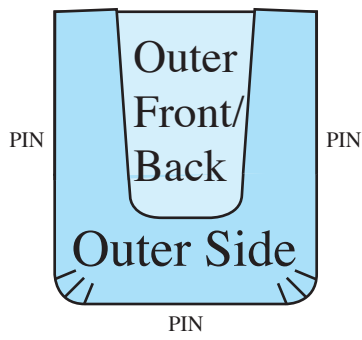

Step 11

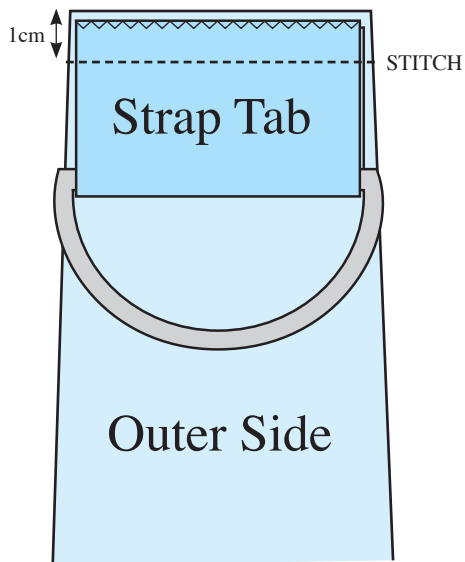

Step 12

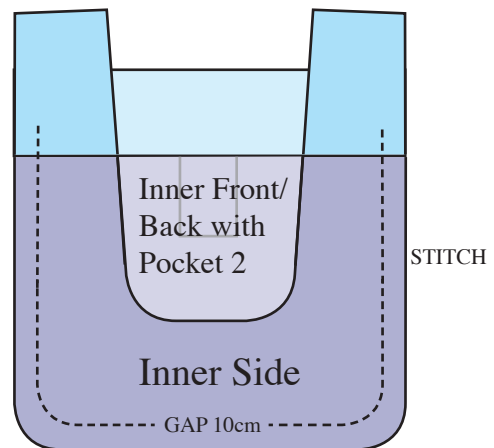
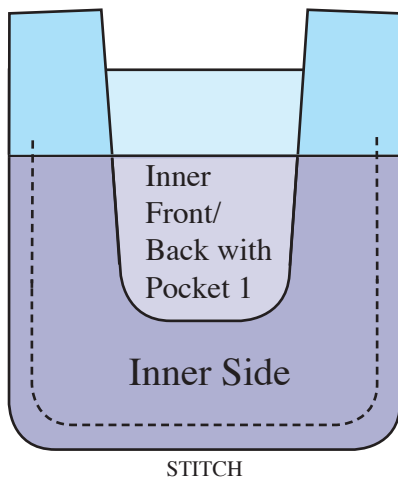

Step 13

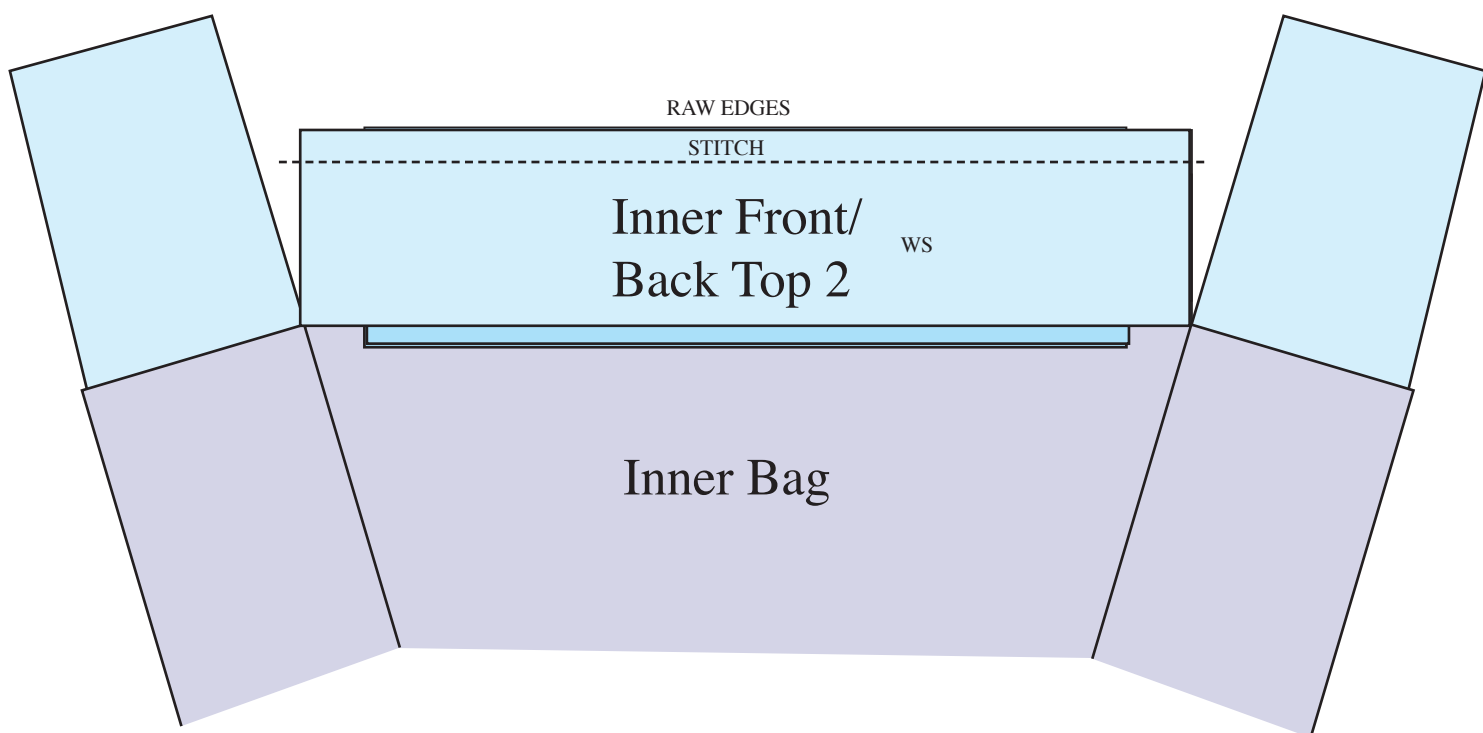
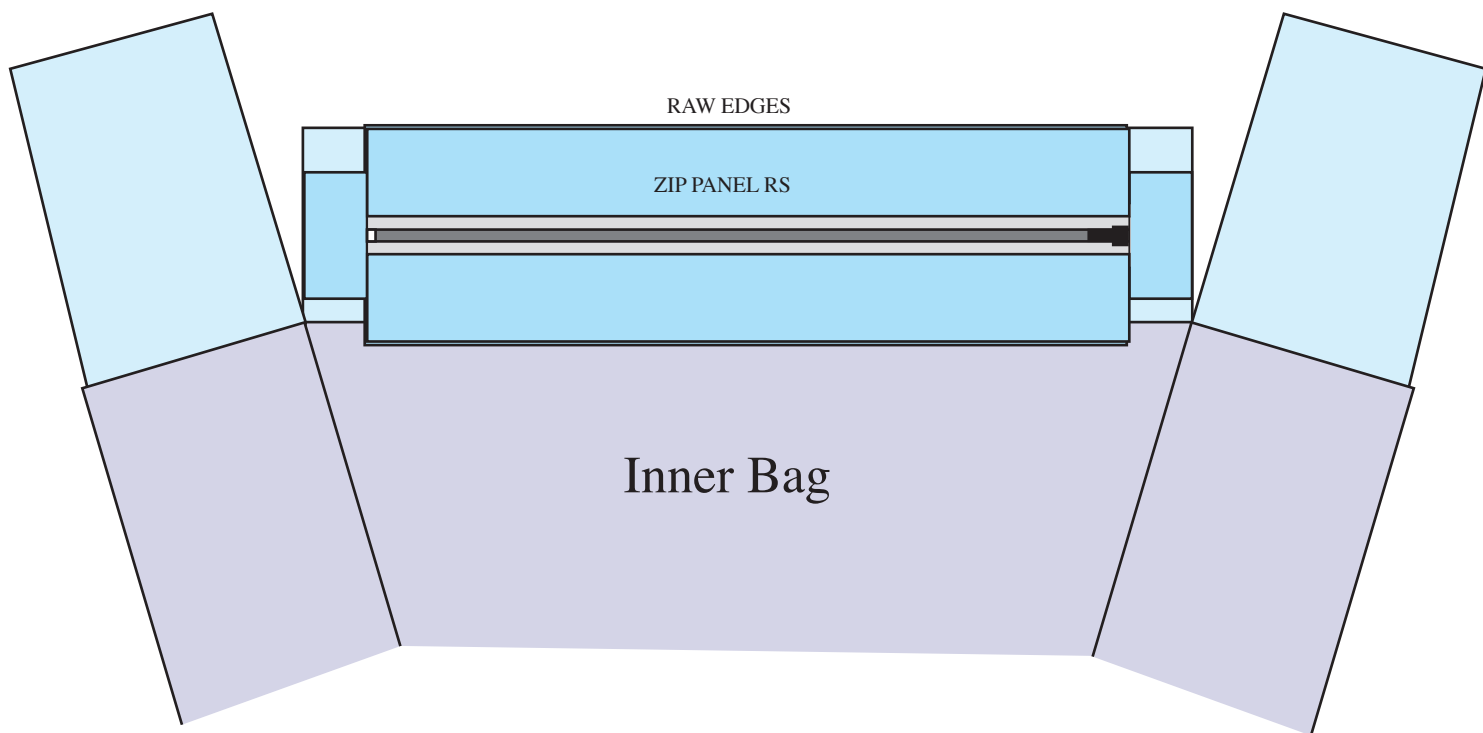

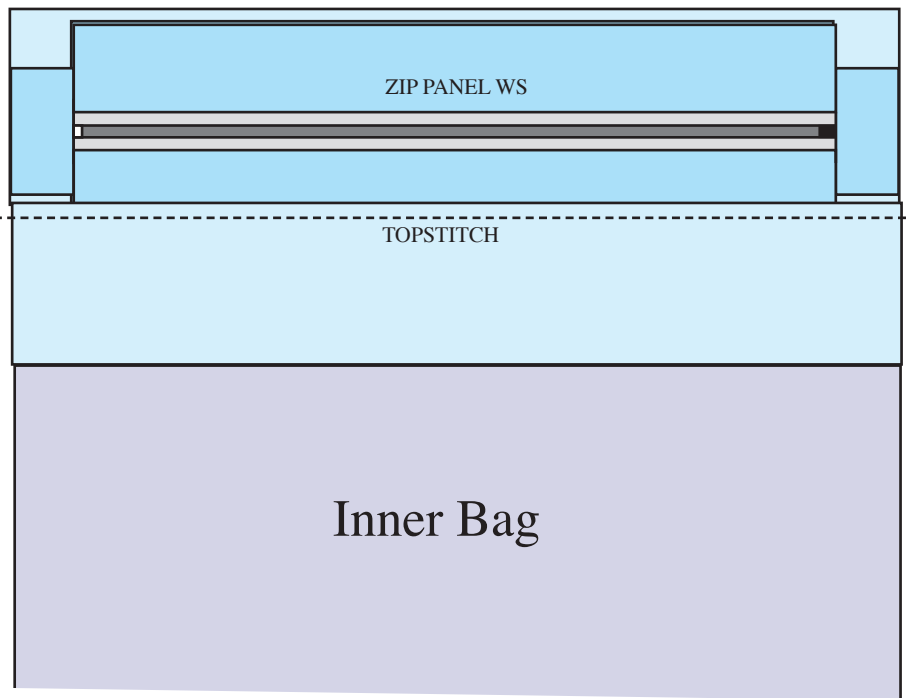
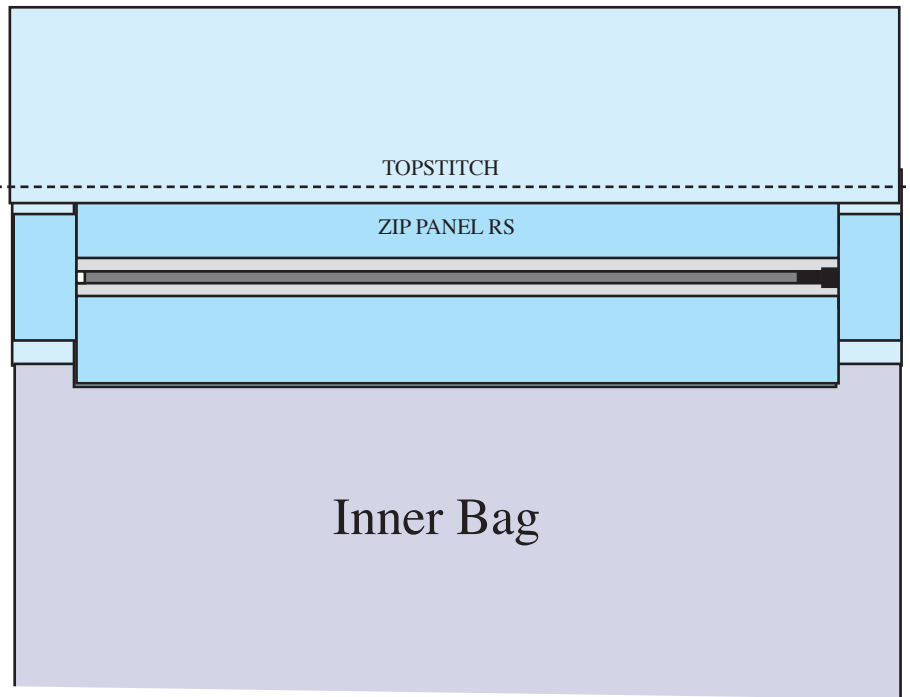

Step 14

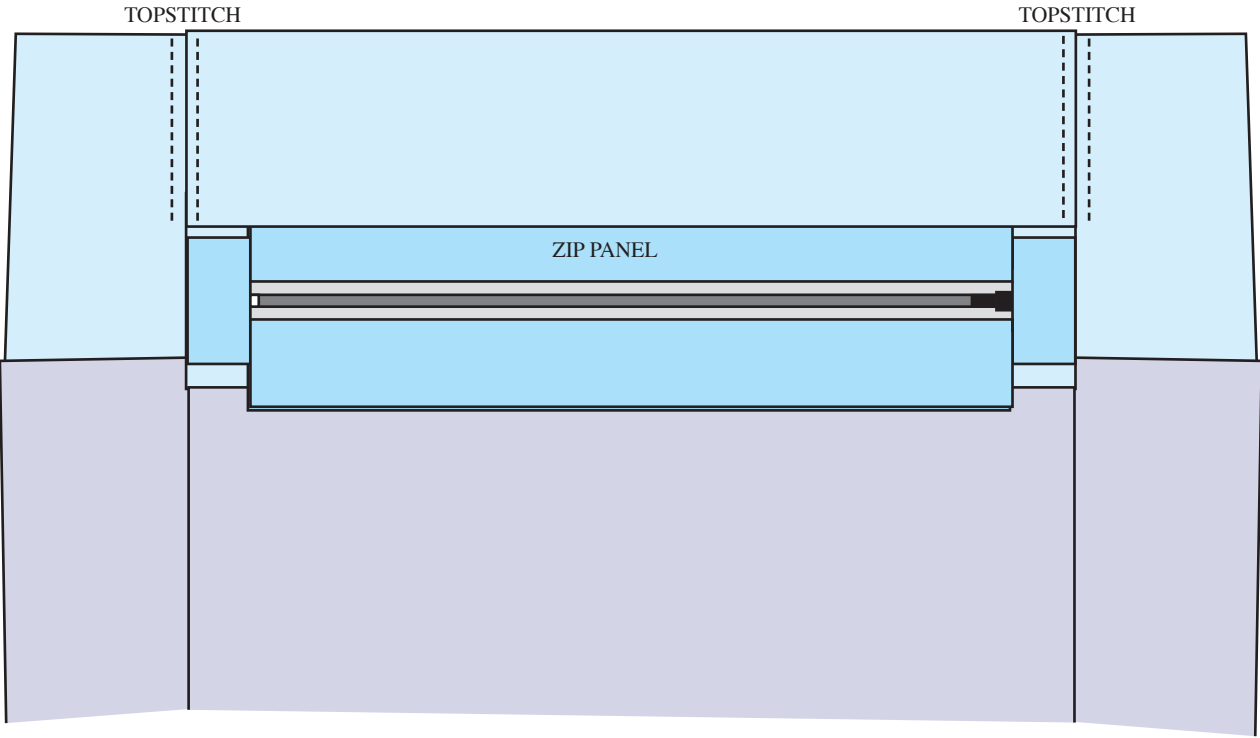
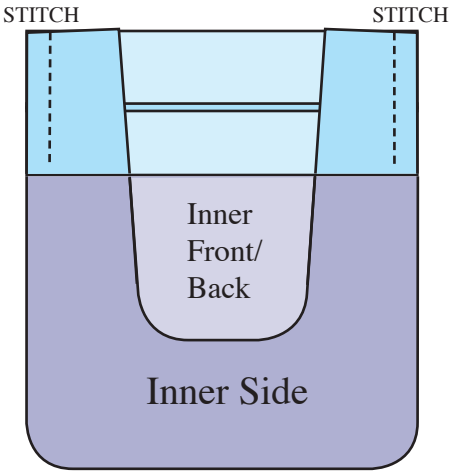

Step 15

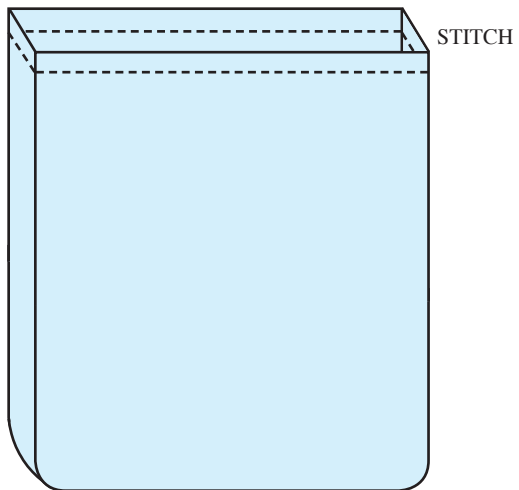
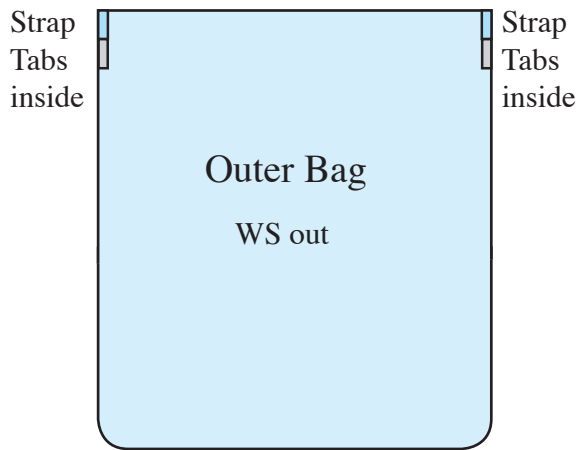
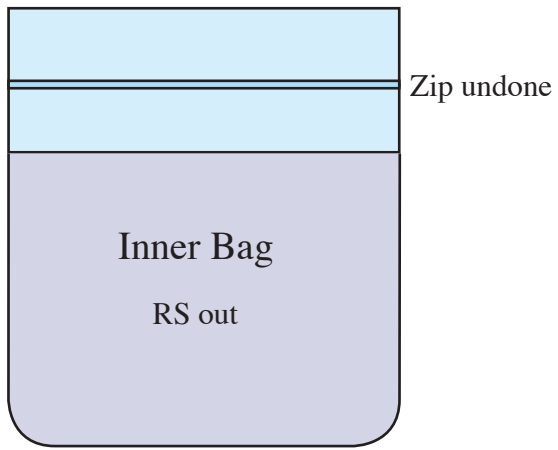

Step 16

